





HORGANS



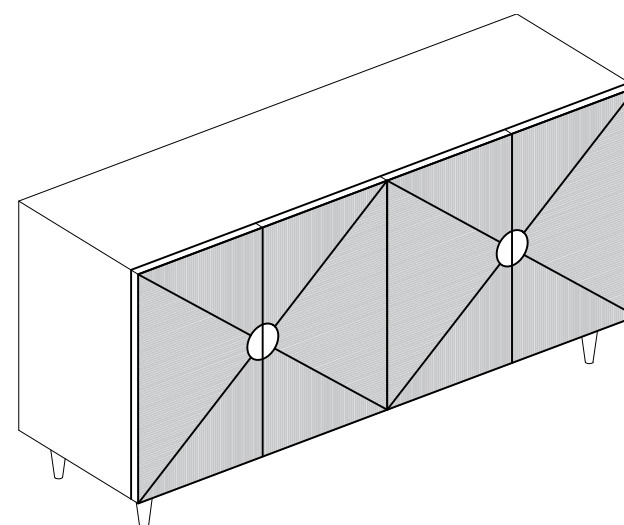
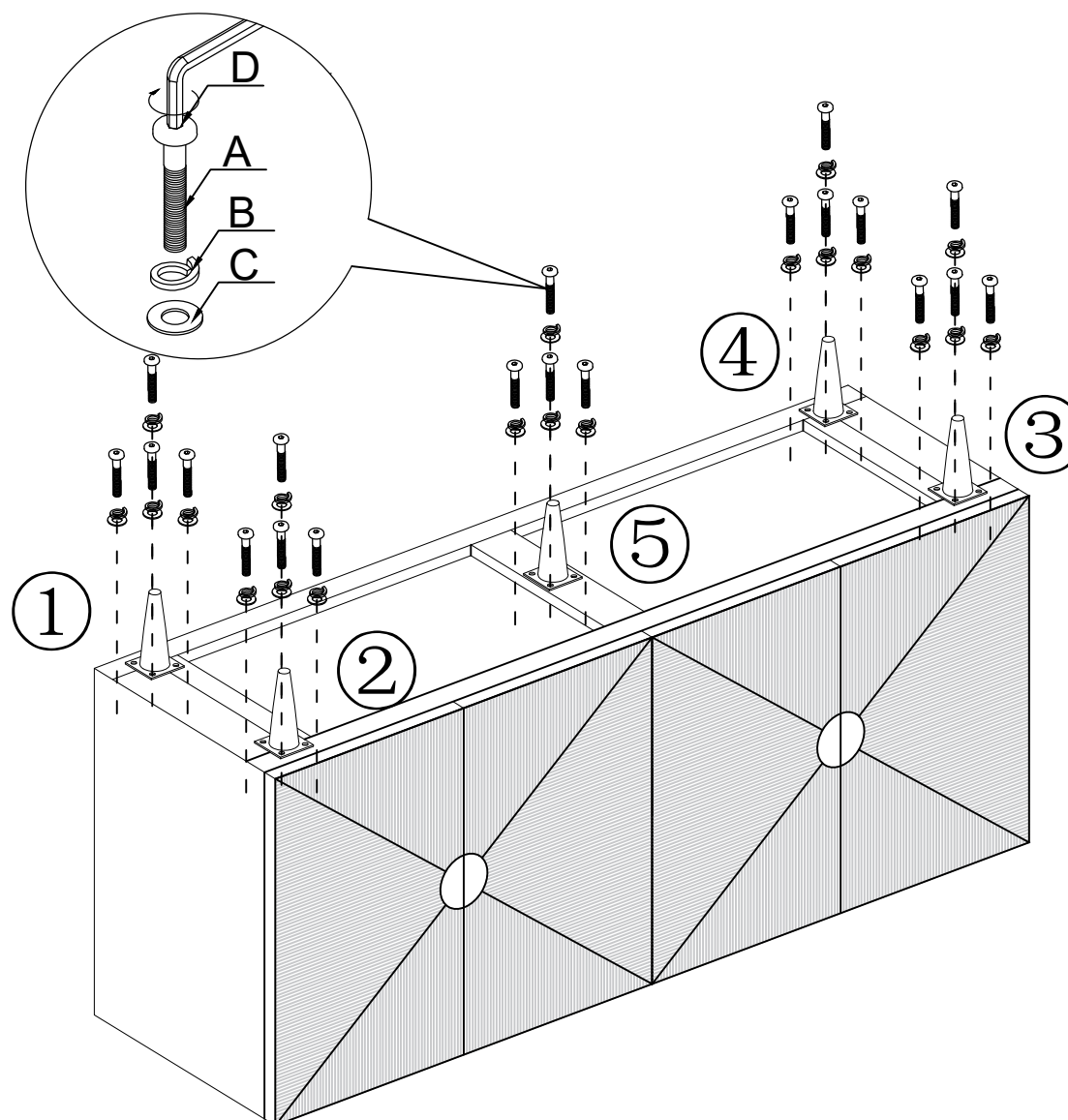

Assembly Instructions - Page 1

| NO. | ITEM | DESCRIPTION | SPEC. | QTY |
|-----|---|--------------|-------|-------|
| A |  | Hexagon bolt | M8x25 | 20PCS |
| B |  | Lock washer | M8 | 20PCS |
| C |  | Washer | 16x8 | 20PCS |
| D |  | Allen key | M8 | 1PC |



HORGANS

Assembly Instructions - Page 2

| NO. | ITEM | DESCRIPTION | SPEC. | QTY |
|-----|--|-------------------|-------|------|
| E |  | Anti-tip belt | | 2PCS |
| F |  | Screw | M4×20 | 4PCS |
| G |  | Screw | M4×40 | 4PCS |
| H |  | Plastic expansion | | 4PCS |

