

HORGANS

Assembly Instructions

Step 1

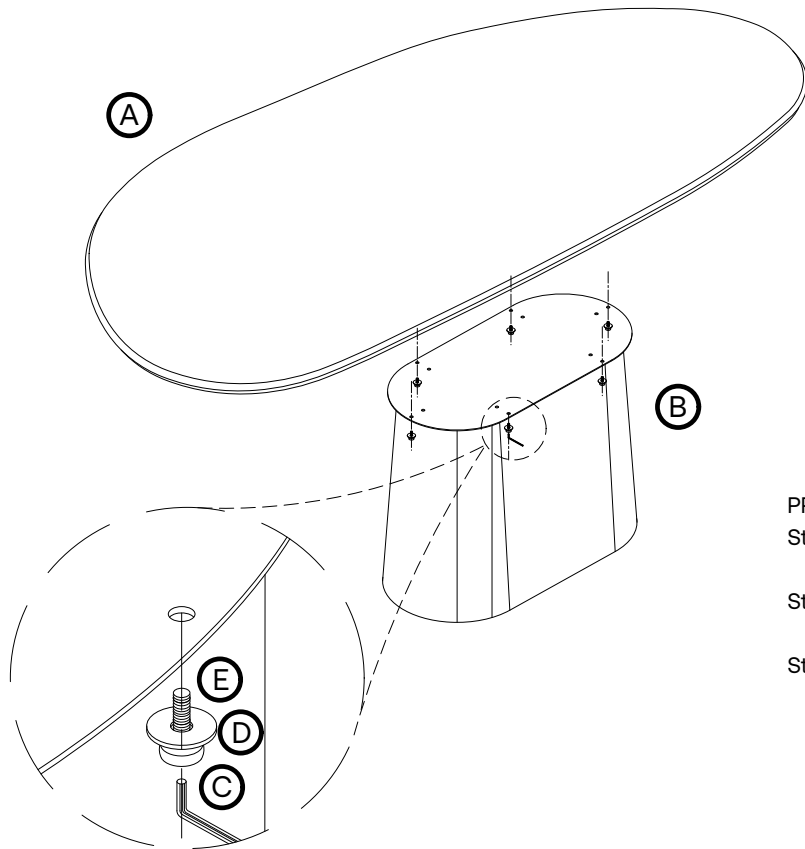

Step 2

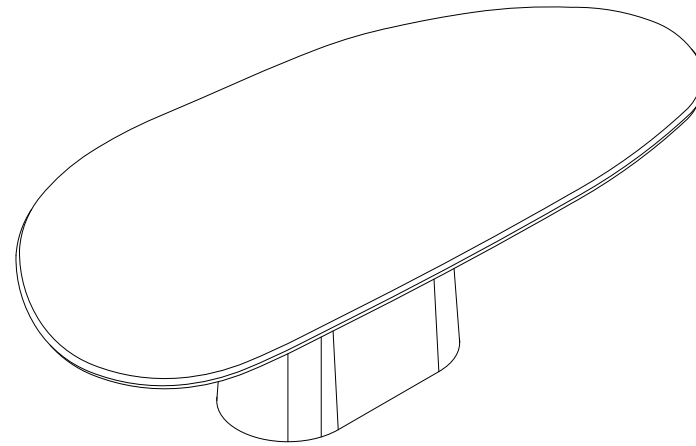





PRECAUTION

Step 1: Place the base in the exact area you would like the table to sit.

Step 2: Place the top on the base, align the holes between the top and base, and fasten screws.

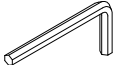
Step 3: If you need to move the table, you must take apart the top and then move the base. If you move the whole table directly, the table will be damaged due to heavy base.

ID	Description	QTY
A	 Top	1
B	 Base	1
C	 L-Key	1
D	 M8x30	6
E	 Washer Ø 20	6